

M7290

SPECIFICATION

Current rating: 3AAC, DC
 Voltage rating: 32VAC, DC
 Operating Temperature: -40 °C--+120 °C
 Contact Resistance: 10mΩ max.
 Insulation resistance: 1000MΩ min.
 Withstanding voltage: 1400V AC/minute
 Material: Housing:Nylon66 UL94V-0
 Terminal: Phosphor bronze, Tin-plated
 Wire range: AWG 24 to 22
 GWT:750 °C IEC-60335-1

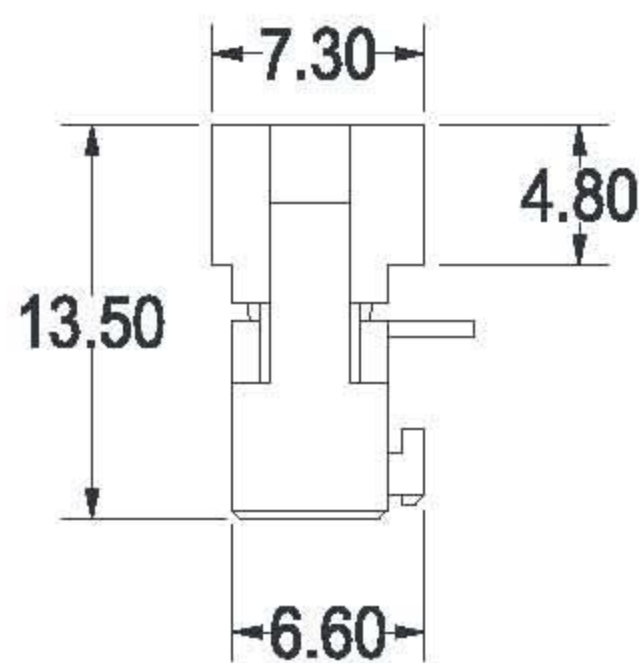
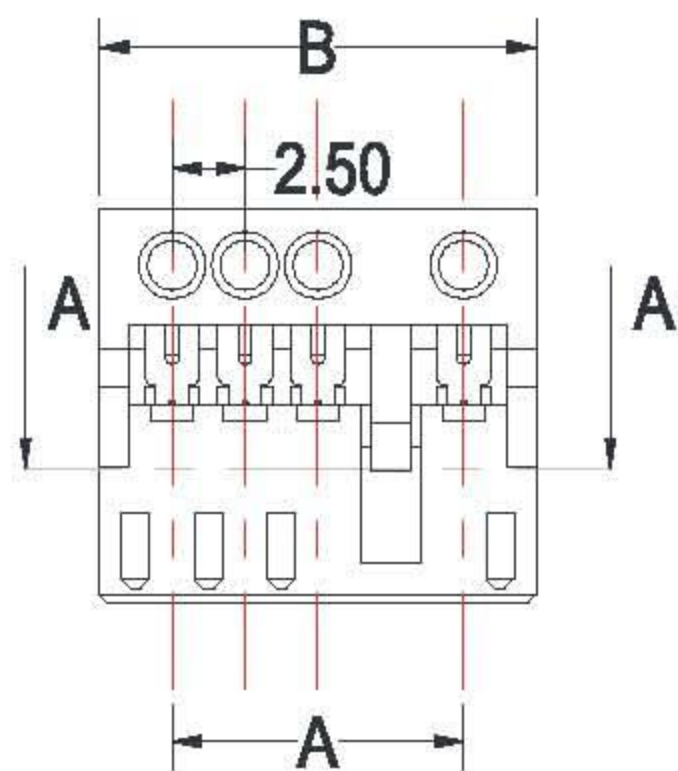
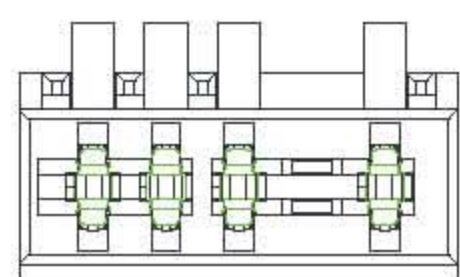

Dimension		
Pos. No.	A	B
2	2.5	7.5
3	5.0	10.0
4	7.5	12.5
5	10.0	15.0
6	12.5	17.5
7	15.0	20.0
8	17.5	22.5
9	20.0	25.0
10	22.5	27.5
11	25.0	30.0
12	27.5	32.5
13	30.0	35.0
14	32.5	37.5
15	35.0	40.0
16	37.5	42.5
17	40.0	45.0
18	42.5	47.5
19	45.0	50.0
20	47.5	52.5

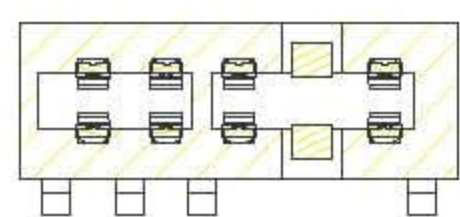

SECTION: A-A

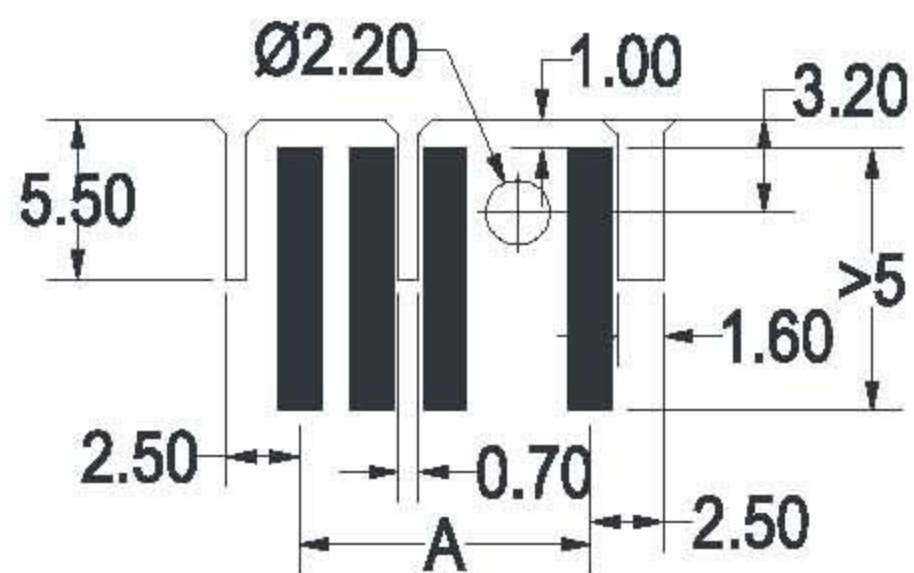
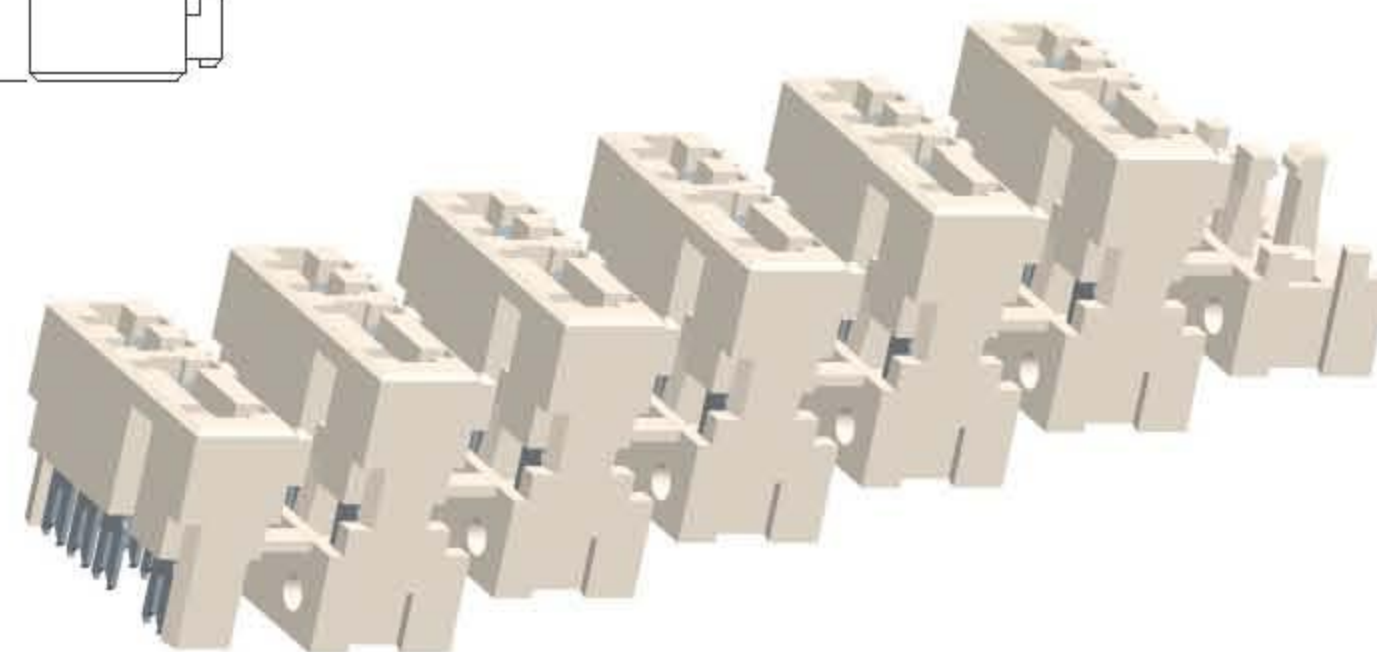
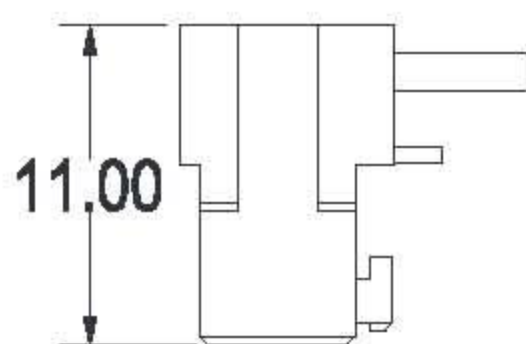

PCB Layout

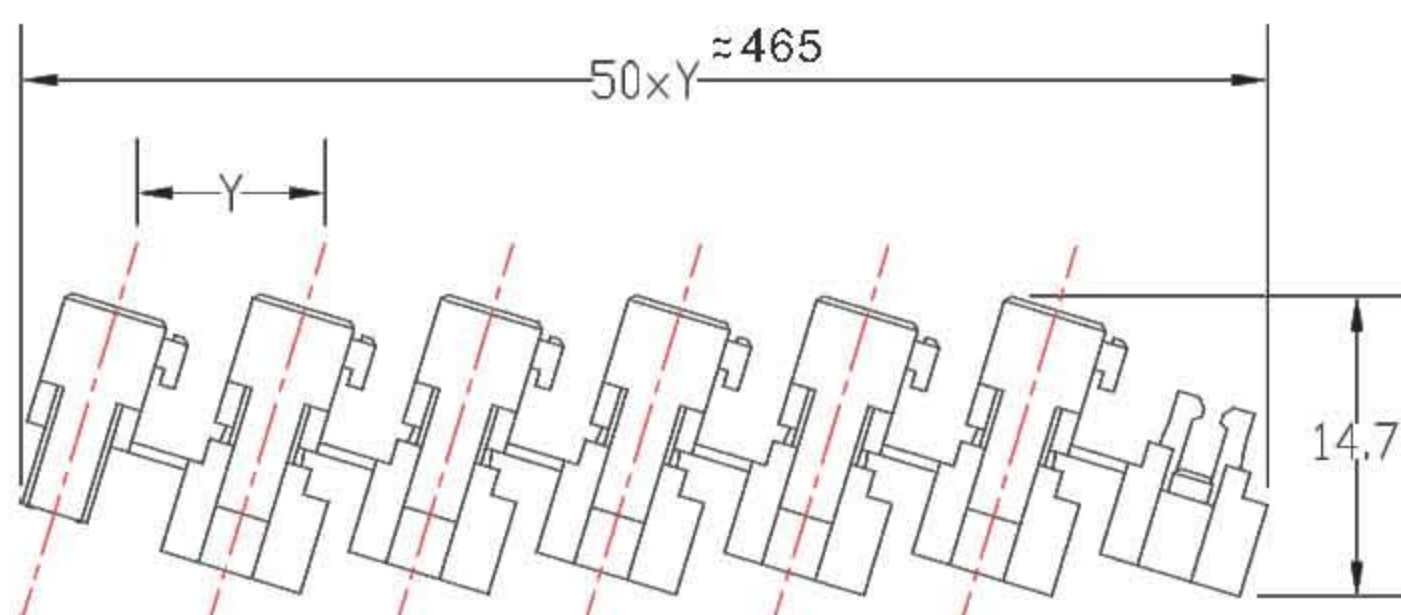

M7290 Part Number Definition

M7290-X-X X-X-X-X(X)

